



TRANSFORMER SPECIFICATIONS

Please read carefully before installation

T-CX Series Transformers



NOTES:

1. Output voltage in table 1 with 120VAC applied and fully loaded.
2. Maximum no load input current : 1.4A
3. Enclosure Temperature does not exceed 75 °C in a 40 °C ambient, fully loaded.
4. The actual transformer 1200VA is encapsulated in the enclosure.
5. The transformer is dimmable with all dimmers that provide symmetrical form of the current under any condition.
6. Input leads are 18 AWG output leads are 12 AWG. Lead insulation is 105 °C.
7. The transformer uses a class B (130 °C) insulation system.
8. The transformer has a manual reset thermal 15A circuit breaker on the primary side, or manual reset magnetic 25A circuit breaker on the secondary side.
9. Wiring compartment has 4 knockouts sized for 3/4 inch screw cable connectors.
10. The wiring compartment cover hinged with rivets and opens vertically from bottom to top.
11. The enclosure, available in black powder coated or stainless steel is NEMA 3R rated.
12. The Transformer is UL listed. UL file number: E194005.
13. The label contains Corona Lighting catalog number and electrical rating.
14. The boost tap option is indicated by the marked check box on the label.

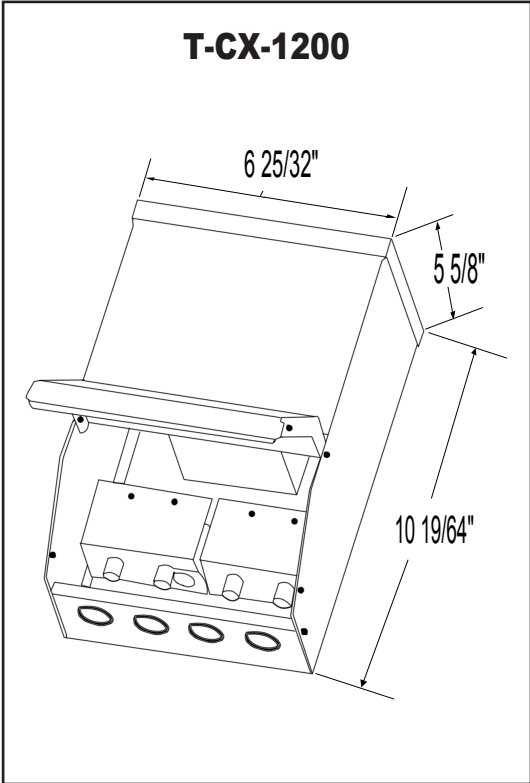

Table 1.

Output Volts	
120VAC	120VAC
4 x 12	4 x 13

DESCRIPTION:
Compact outdoor 12V
1200VA Low voltage
Transformer.

**ENCLOSURE TYPE
3R OUTDOOR**

